



Custom Dynamics® TruFLEX® Installation Instructions

We thank you for purchasing the Custom Dynamics® TruFLEX® LEDs. Our products utilize the latest technology and high quality components to ensure you the most reliable service. We offer one of the best warranty programs in the industry and we back our products with excellent customer support, if you have questions before or during installation of this product please call Custom Dynamics® at 1(800) 382-1388.

Product Listing for TruFLEX® Instructions

Single Color Amber or Red LED TruFLEX® LEDs in clear, amber, red or smoked tubing (page 3):

TF5	TF30	TF60	TF115
TF10	TF40	TF65	
TF15	TF45	TF75	
TF20	TF50	TF95	
TF25	TF55	TF100	

Universal Integrated Run/Brake/Turn TruFLEX® 2 section or 3 section with dual color amber and/or red LEDs:

<u>Amber/Red (pg.4)</u>	<u>Red/Red/Red (pg.4)</u>	<u>Red/Red (pg.6)</u>
TF40ARC	TF115RC	TF110RR
TF40ARS	TF115RR	TF110RS
TF115ARC	TF115RS	
TF115ARS		

Dual Color Amber/Red LEDs, in smoked tube (page 5): (requires 2 units for left and right turns)

TFDC5S	TFDC30S
TFDC10S	TFDC35S
TFDC15S	TFDC40S
TFDC20S	TFDC75S
TFDC25S	

2 Section Integrated Dual Color TruFLEX® (page 5):

TFDC50S	TFDC70S	TFDC90S	TFDC110S
---------	---------	---------	----------

Standard TruFLEX® Driving Lights, White LEDs .5 spacing (page 3):

TF6WC	TF18WC
TF12WC	TF24WC

DOT specifies signal color by location:
Amber = Front or Rear turn
Amber = Front running
Red = Rear run/brake/turn

TruFLEX® Dual Converter Index

Convert TruFLEX® from Single Wire to Dual Wire. Used for Tail Light and Turn Signal Applications. Example: will convert single hot wire to: Running (30% Intensity) and Brake (100% Intensity). Select the Converter Based on the Number of TruFLEX® LEDs you are Converting from Single Wire to Two Wire.

<u>Single Color LED Application</u>	<u>Dual Color Amber/Red Application</u>
TFC1 (5-10 LEDs)	TFDC1 (5-25 LEDs)
TFC2 (15-25 LEDs)	TFDC2 (30-45 LEDs)
TFC3 (30-60 LEDs)	TFDC3 (50-110 LEDs)
TFC4 (65-120 LEDs)	
TFC5 (125-160 LEDs)	

Note: the lower number of the converter = lower running power = more contrast

TruFLEX® Technical Information:

Board: FR4 LED mounting board

LED's: 120 Degree Viewing Angle, Genesis® Surface Mount type available in amber, red, or white

Voltage: Wide Operating Range: 9-14 VDC

Current Draw: Approximately 25mA for every 5 LEDs

Wire: 36" (3 ft.) Stranded conductor wire 26 AWG gauge

Housing:

- Flexible UV stable channel engineered for maximum flexibility
- Dimensions: 0.34" Wide X 0.30" High X Length
- Color: Choice of Clear, Amber, Red, or Smoked
- Light Dispersion: Facet design increases LED viewing angle
- End Cap: 100% Sealed with UV Stable Military Grade RTV (MIL-A-46146)

Mounting: Pre-Taped with 3M™ Automotive Acrylic Plus Attachment Tape

The TruFLEX® product is designed to be used as auxiliary lighting on any 12VDC system including motorcycles, automobiles, trucks, boats, ATVs, and snow mobiles for the following applications:

- Running lights
- Turn signals
- Brake lights

Questions? Call us at: 1 (800) 382-1388 M-TH 8:30AM-5:30PM / FR 9:30AM-5:30PM EST

Installation Instructions - Page 2



Please read all Information below before Installation

Important: This product is designed and intended for use as auxiliary lighting only. It is NOT intended to replace any original equipment lighting installed on the vehicle and should not be used for that purpose. This product must be wired so that it does not interfere with any original equipment lighting.

Note: Please read all instructions before beginning installation. Some wiring knowledge and soldering experience will be helpful. Consult your vehicle detailed service manual for wiring information and color codes. Use a meter or test light to verify wiring before cutting or tapping any vehicle wiring. If the steps contained within are beyond your skillset, do not attempt installation, contact a qualified mechanic or dealership to assist you.

Safety First: Always wear appropriate safety gear including safety glasses when performing any electrical work. It is highly recommended that safety glasses be worn throughout this installation process. Turn fuel supply valve to the off position before starting installation. Be sure vehicle is on level surface, secure and cool.

Warning: Disconnect negative battery cable from battery; refer to owner's manual. Failure to do so may result in electrical shock, injury, or fire. Secure negative battery cable away from positive side of battery and all other positive voltage sources on vehicle.

Note: TruFLEX® products are very flexible but will NOT accommodate hard 90 degree angles. Doing so can cause stress to the board and the LEDs. The product also does not flex from side-to-side, it must be installed in a straight line. Damage or failure from these types of incorrect installation is not covered under warranty.

Recommendation: To increase the adhesion power of the 3M mounting tape, it is recommended to use adhesive primer, sold separately.

Note: 3M Adhesion promoter is classified as a sensitive chemical and cannot ship any carrier by Air or international. Custom Dynamics may not be able to ship promoter with orders in these cases. Contact us for details.

Important: It is recommended that the installation of this product should be performed in a controlled environment of 65 F or above. Allow 24 hours for the tape to properly adhere before riding or washing the bike.

General Product Mounting Instructions

1. Choose the desired location to mount the LED strip(s).
2. Clean the surface thoroughly before mounting with appropriate cleaning method and rubbing alcohol.
3. **Note:** It is recommended to apply adhesive primer to the mounting surface to increase tape adhesion, sold separately. If adhesive primer was purchased, open and apply generously to the mounting surface. Allow 3-4 minutes to dry.
4. Inspect the vehicle and plan the route the wiring will make to the connection point. Keep in mind each unit has 36" of wiring. Consult vehicle detailed service manual for vehicle wiring information and wire color codes. Use a meter or test light to verify vehicle wire functions before connecting.
5. Drill holes if necessary in the mounting surface to allow for the wiring to pass. Feed the wiring through the holes.
6. Remove the Red backing from the Tape and carefully mount in the desired location, paying attention to the desired level and center. Take care in this step as once the tape adheres to the surface, it will be very hard to remove and re-apply and is not recommended.
7. Dress the wiring with shrink tubing (not included) as needed to protect wiring from sharp metal or openings, then run the wiring along the chosen route from step 4. Make sure wiring cannot be accidentally cut, pinched, or frayed by moving or sharp parts. Keep wiring from coming in direct contact with high heat components.
8. Once you have reached the chosen connection point, trim any excess wiring from LED wires the and prepare the wiring ends by stripping back the insulation.

Wiring the Connections

1. All single color TruFLEX® are a 2 wire power system. Black is always Ground, which should be connected to a suitable ground wire in the vehicle's wiring harness or directly to the Negative [-] terminal of the battery. The Colored wire is always the Power [+] which should be connected to the vehicle turn, brake, or running light positive power wire depending on desired application.
2. All dual color and 2 or 3 section TruFLEX® will have more wires depending on configuration, but the same color rules apply. Black is ground and colored wires are positive.
3. Depending on the type of TruFLEX® you have purchased (see page 1 for product listing) and which converters purchased, please refer to the corresponding pages for wiring diagrams and scenarios.

Installation Instructions - Page 3

Single Color Amber or Red LED TruFLEX® LEDs in clear, amber, red or smoked tubing

Part Numbers:

TF5	TF30	TF60	TF115
TF10	TF40	TF65	
TF15	TF45	TF75	
TF20	TF50	TF95	
TF25	TF55	TF100	

Use weatherproof splice connectors or Posi-taps™ for connections or solder wire connections.

Make sure to insulate solder connections with heat shrink tubing or electrical tape.

If using as Turns, 2 TruFLEX® LED strips are required for Left and Right Turn.

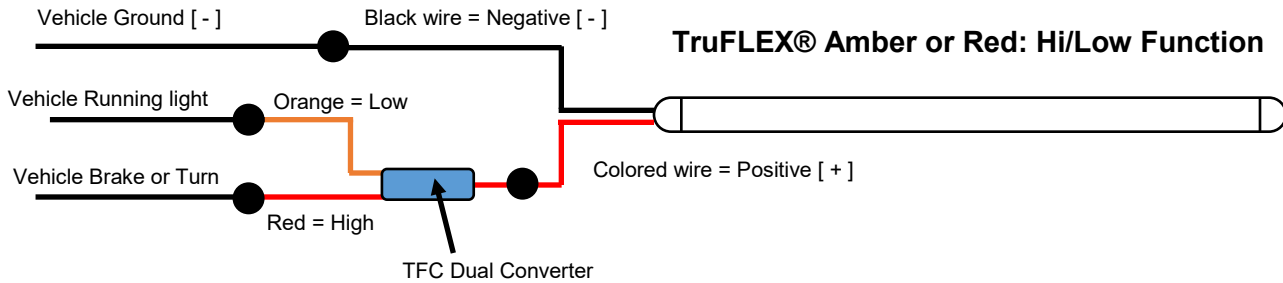
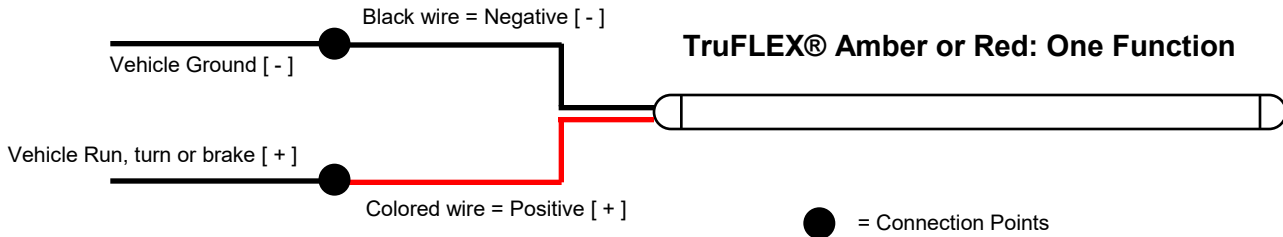

Standard TruFLEX Driving Lights, White LEDs (.5 spacing)

Part Numbers:

TF6WC	TF18WC
TF12WC	TF24WC

Use weatherproof splice connectors or Posi-taps™ for connections or solder wire connections.

Make sure to insulate solder connections with heat shrink tubing or electrical tape.

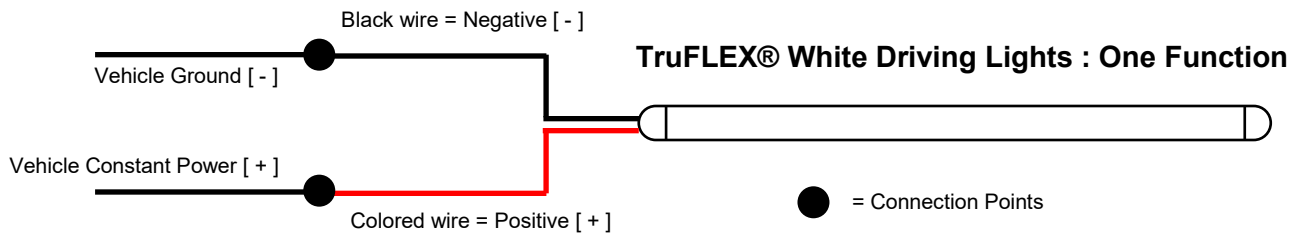

Installation Instructions - Page 4

Universal Integrated Run/Turn or Run/Brake/Turn TruFLEX® 3 section Amber/Red/Amber

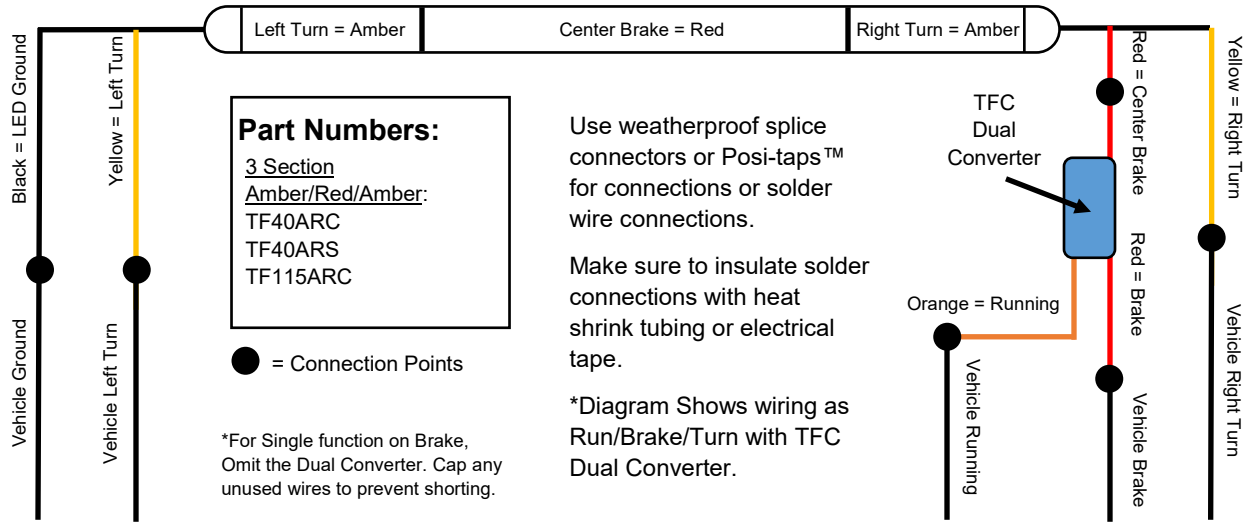

Universal Integrated Run/Turn or Run/Brake/Turn TruFLEX® 3 section Red/Red/Red

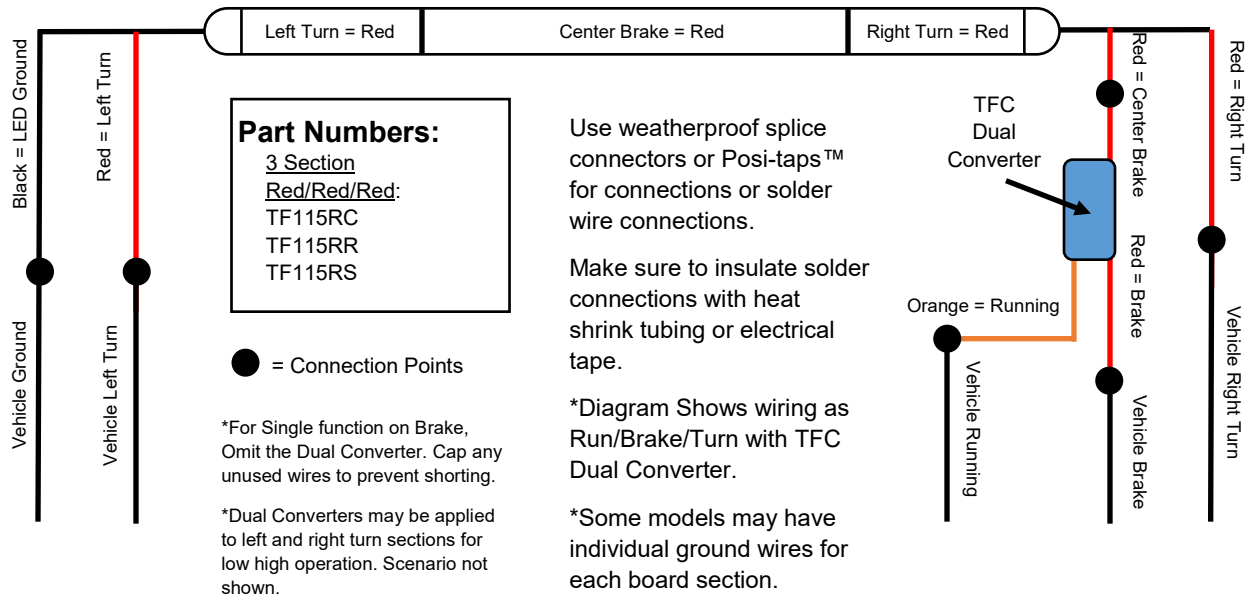

Installation Instructions - Page 5

TruFLEX® Dual Color Amber/Red LEDs, in smoked tube

Part Numbers:

TFDC5S	TFDC30S
TFDC10S	TFDC35S
TFDC15S	TFDC40S
TFDC20S	TFDC75S
TFDC25S	

Use weatherproof splice connectors or Posi-taps™ for connections or solder wire connections.

Make sure to insulate solder connections with heat shrink tubing or electrical tape.

*Diagram Shows wiring as Run/Brake/Turn with TFC Dual Converter.

*2 Units are required for left and right turns.

*For Single function on Brake, Omit the Dual Converter. Cap any unused wires to prevent shorting.

● = Connection Points

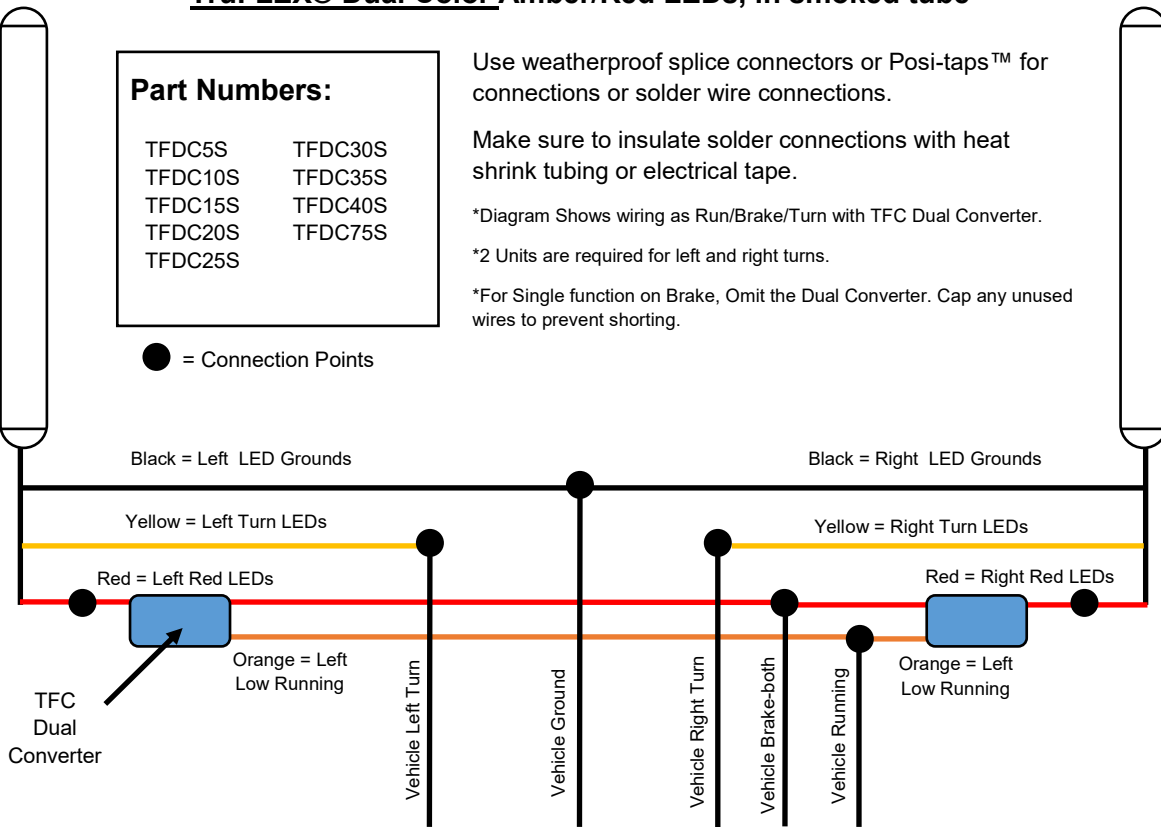

TruFLEX® Dual Color 2 Section 50/50 split Amber/Red (Run/Brake/Turn)

Part Numbers:

2 Section Amber/Red
 TFDC50S
 TFDC70S
 TFDC90S
 TFDC110S

Note: Only (1) dual converter required for these parts.

Use weatherproof splice connectors or Posi-taps™ for connections or solder wire connections.

Make sure to insulate solder connections with heat shrink tubing or electrical tape.

*For Single function on Brake, Omit the Dual Converter. Cap any unused wires to prevent shorting.

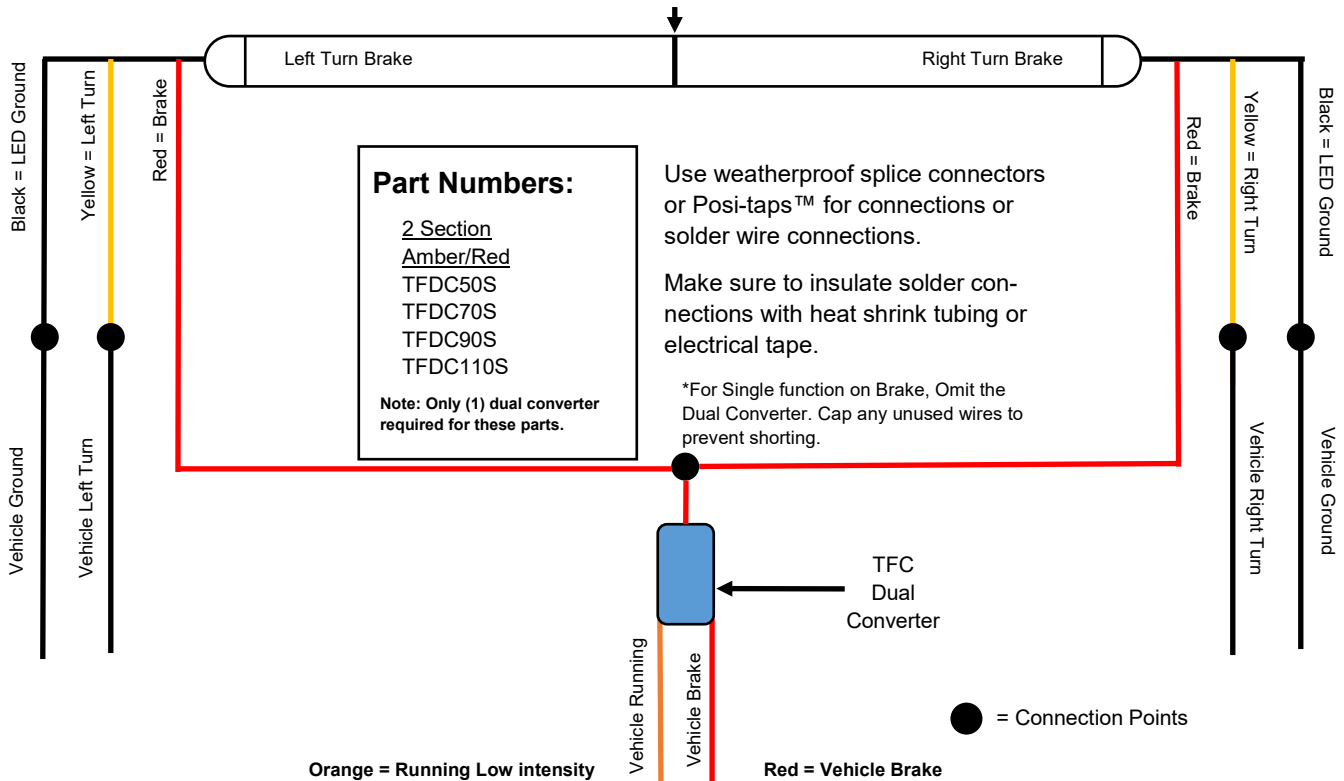

Questions? Call us at: 1 (800) 382-1388

M-TH 8:30AM-5:30PM / FR 9:30AM-5:30PM EST

Installation Instructions - Page 6

Universal Integrated Run/Turn or Run/Brake/Turn TruFLEX® 2 section Red/Red

TruFLEX® TF110RR 2 Section 50/50 split Red/Red (Brake/Turn Only)

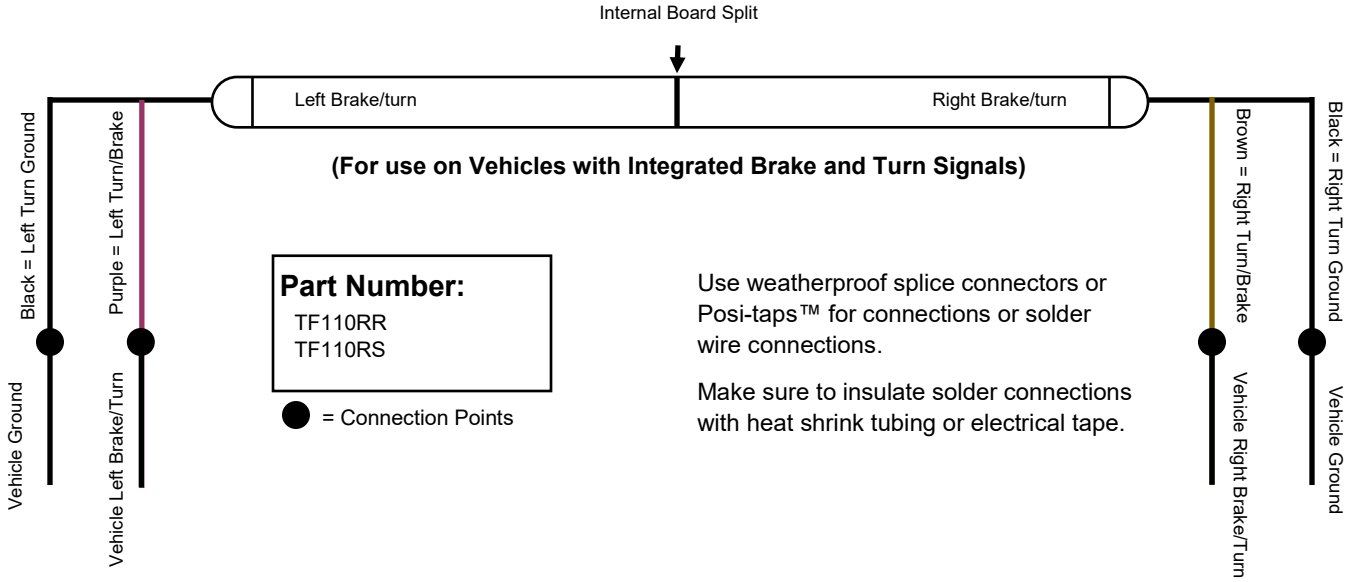

TruFLEX® TF110RR 2 Section 50/50 split Red/Red (Run/Brake/Turn w/converters)

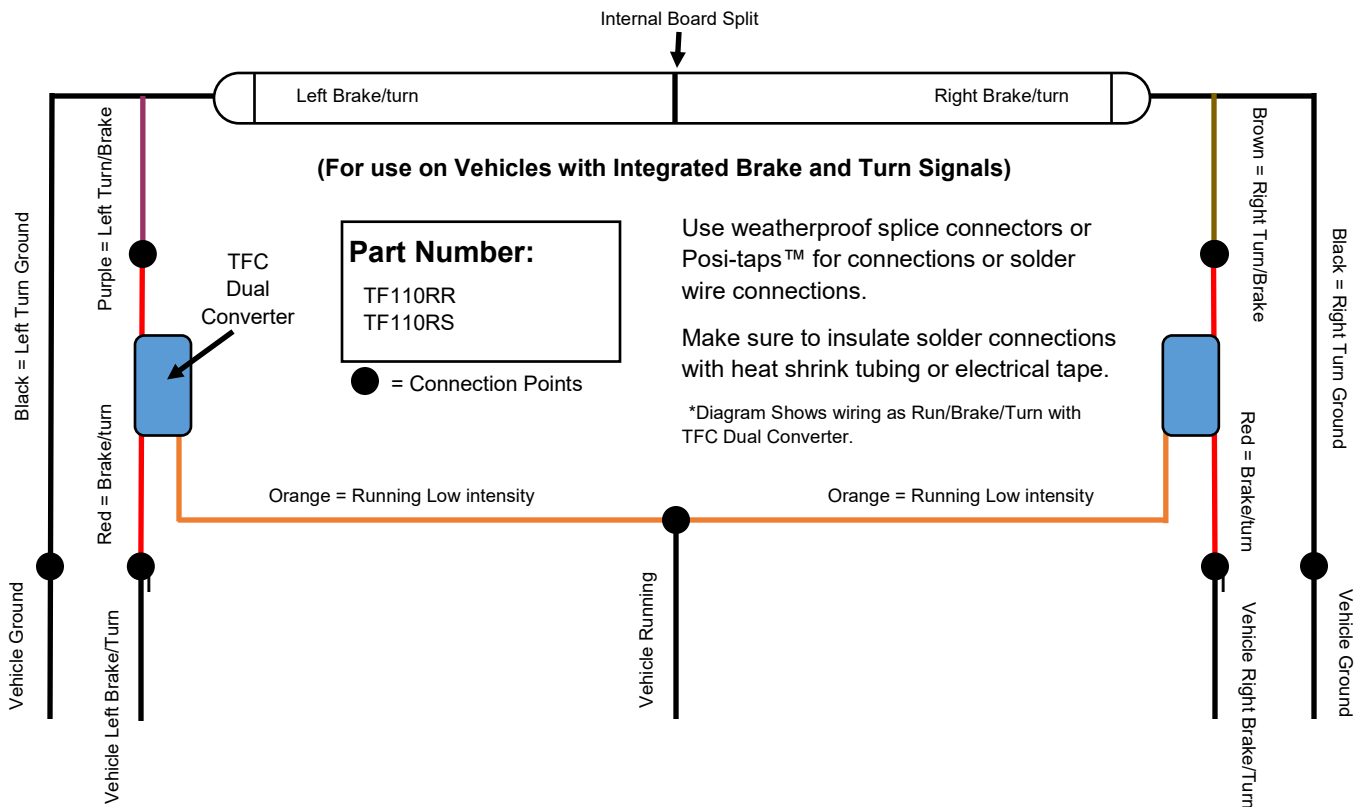

Questions? Call us at: 1 (800) 382-1388 M-TH 8:30AM-5:30PM / FR 9:30AM-5:30PM EST