



## Custom Dynamics® LED Headlamp Adapter Installation Instructions

We thank you for purchasing the Custom Dynamics® Headlamp Adapter. Our products utilize the latest technology and high quality components to ensure you the most reliable service. We offer one of the best warranty programs in the industry and we back our products with excellent customer support, if you have questions before or during installation of this product please call Custom Dynamics® at 1(800) 382-1388.

**Part Number: CDTB-H42H9H11**

**Package Contents:**

- Headlamp Adapter Assembly (1)
- Instructions

Fits: 2014-2019 Harley-Davidson® Road King® & Road King® Special Models.

**Installation:**

1. Follow the instructions in the TruBEAM™ Headlamp installation guide for installing headlamp.
2. Plug the H4 connector on the adapter to the TruBEAM™ H4 connector.
3. Plug the adapter 2 pin low beam connector (identified by BLACK and BLUE or BLACK and WHITE wires) into the bike's headlamp harness low beam connector (identified by BLACK and BLUE/YELLOW wires). See diagram below.
4. Plug the adapter 2 pin high beam connector (identified by BLACK and RED wires) into the bikes headlamp harness high beam connector (identified by BLACK and BLUE/WHITE wires). See diagram below.
5. Halo (optional): Splice the WHITE wire from the TruBEAM™ lamp to the position lamp connector in the bike's headlamp harness. The spade connector may be removed if needed.

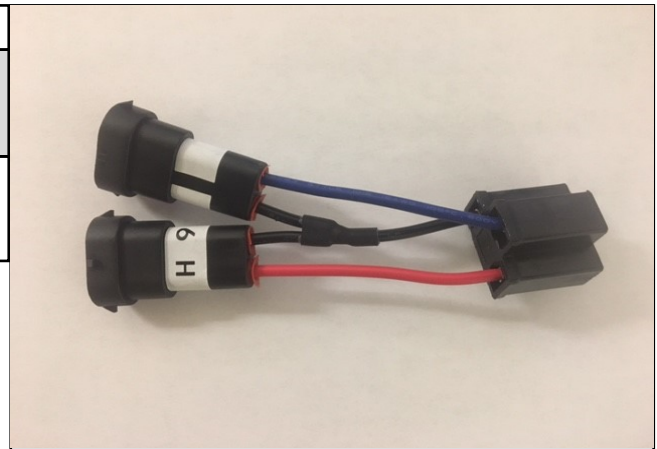

### ATTENTION



Please read all Information below before Installation

**Function Note:** The Halo function should be spliced in on the Position Lamp Connector (US Models) or to the Low Beam Positive Connector wire (HDI Models). The White wire will need to be extended depending on the location of the harness connector.

**Important:** Make sure no wires of the harness can be pinched during installation and that they will not be exposed to water spray, excessive heat or moving parts.

**Warning:** Disconnect negative battery cable from battery; refer to owner's manual. Failure do to so may result in electrical shock, injury, or fire. Secure negative battery cable away from positive side of battery and all other positive voltage sources on vehicle.

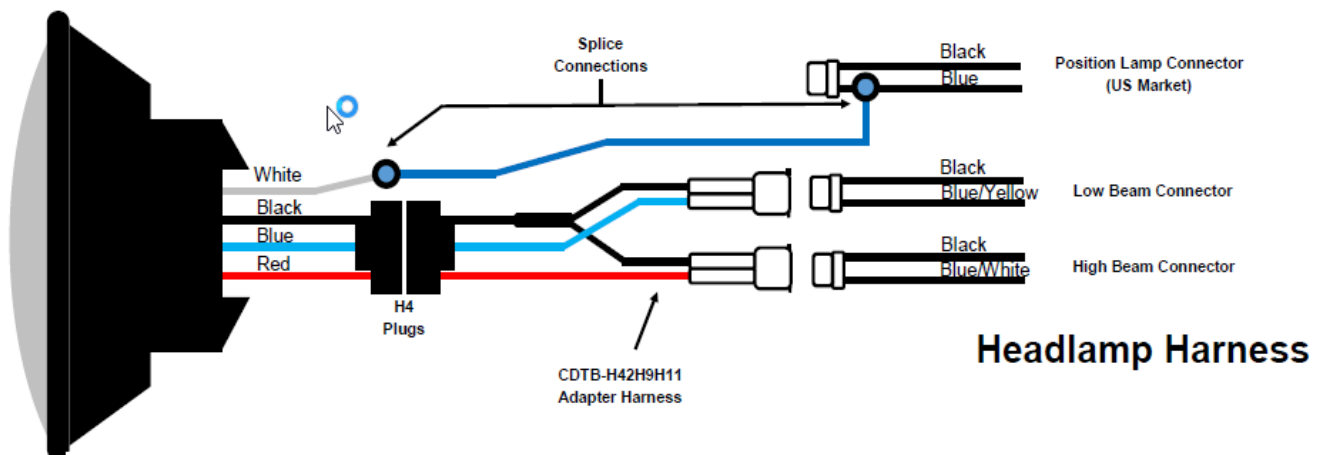

Questions? Call us at: 1 (800) 382-1388 M-TH 8:30AM-5:30PM / FR 9:30AM-5:30PM EST